

SPACE



EVO10

IP44

IK04

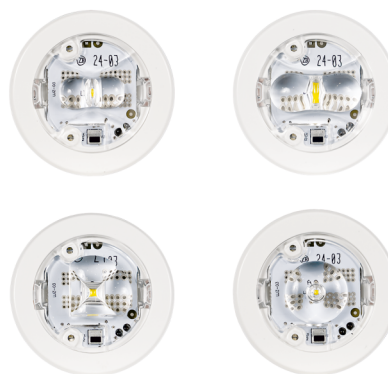

EVO10
GARANTIE
10 JAAR

— Installatie —

| | | |
|---------|-----------|---|
| Muur | Oppervlak | ✘ |
| | Verzonken | ✘ |
| Plafond | Oppervlak | ✘ |
| | Verzonken | ✓ |

— Afmetingen (mm) —

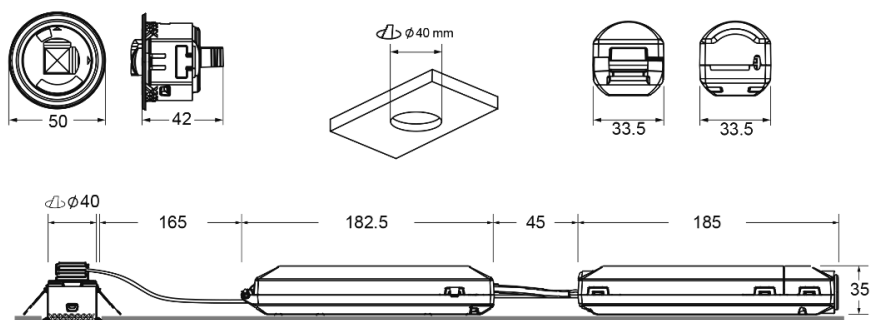

— Specificatie —

 Lichaam: Gerecycled Polycarbonaat

 IP44

 IK04

 Noodverlichting uitgang: 280 ~ 420 lm

 Autonomie: 1 h, 3 h
Batterij: LiFePO₄

 Oplaadtijd: 12 h

 Levering: 230V 50Hz

 LED-temperatuur: 4000 K

 Gebruikstemperatuur: 0/40 °C

 Zelftest

 DALI2

— Technische naleving —

EN-303-446-1 EN-60598-1 EN-60598-2-22
EN-62034 EN-62386

— Certificaten —

— Bereik —



| | Noodbedrijf | Type* | Lens | Duur | Batterij | Artikelnummer |
|----------|-------------------|--------|--------------------|------------------|--------------------------------|--------------------------------|
| Zelftest | 420 lm | NP | Antipanieklens | 1 h | 6.4V-1.5Ah LiFePO ₄ | LSLX3400LX |
| | 280 lm | NP | Voor Vluchtroute | 1 h | 6.4V-1.5Ah LiFePO ₄ | LSLX3251LA |
| | 370 lm | NP | Voor Vluchtroute + | 1 h | 6.4V-1.5Ah LiFePO ₄ | LSLX3402LA |
| | 380 lm | NP | Hoeklens | 1 h | 6.4V-1.5Ah LiFePO ₄ | LSLX3403LA |
| | 400 lm | NP | Narrow | 1 h | 6.4V-1.5Ah LiFePO ₄ | LSLX3404LA |
| | 420 lm | NP | Antipanieklens | 1 h | 6.4V-1.5Ah LiFePO ₄ | LSLX3400LA |
| | 285 lm | NP | Voor Vluchtroute | 3 h | 6.4V-3.0Ah LiFePO ₄ | LSLX3251LA3 |
| | 370 lm | NP | Voor Vluchtroute + | 3 h | 6.4V-4.0Ah LiFePO ₄ | LSLX3402LA3 |
| | 380 lm | NP | Hoeklens | 3 h | 6.4V-4.0Ah LiFePO ₄ | LSLX3403LA3 |
| | 400 lm | NP | Narrow | 3 h | 6.4V-4.0Ah LiFePO ₄ | LSLX3404LA3 |
| | 420 lm | NP | Antipanieklens | 3 h | 6.4V-4.0Ah LiFePO ₄ | LSLX3400LA3 |
| | Draadloos SmartZ® | 280 lm | NP | Voor Vluchtroute | 1 h | 6.4V-1.5Ah LiFePO ₄ |
| 370 lm | | NP | Voor Vluchtroute + | 1 h | 6.4V-1.5Ah LiFePO ₄ | LSLX3402LW |
| 380 lm | | NP | Hoeklens | 1 h | 6.4V-1.5Ah LiFePO ₄ | LSLX3403LW |
| 400 lm | | NP | Narrow | 1 h | 6.4V-1.5Ah LiFePO ₄ | LSLX3404LW |
| 420 lm | | NP | Antipanieklens | 1 h | 6.4V-1.5Ah LiFePO ₄ | LSLX3400LW |
| 285 lm | | NP | Voor Vluchtroute | 3 h | 6.4V-3.0Ah LiFePO ₄ | LSLX3251LW3 |
| 370 lm | | NP | Voor Vluchtroute + | 3 h | 6.4V-4.0Ah LiFePO ₄ | LSLX3402LW3 |
| 380 lm | | NP | Hoeklens | 3 h | 6.4V-4.0Ah LiFePO ₄ | LSLX3403LW3 |
| 400 lm | | NP | Narrow | 3 h | 6.4V-4.0Ah LiFePO ₄ | LSLX3404LW3 |
| 420 lm | | NP | Antipanieklens | 3 h | 6.4V-4.0Ah LiFePO ₄ | LSLX3400LW3 |



12 / 15 / 18

*NP: Niet permanent. De armatuur werkt alleen op noodstroom bij uitval van de normale netvoeding.

— Beschikbare kleuren —



Voor de zwarte versie voegt u "N" toe aan het einde van het onderdeelnummer.

Afstandstabel

Berekend ter referentie LSLX3403LW3 (380 lm)

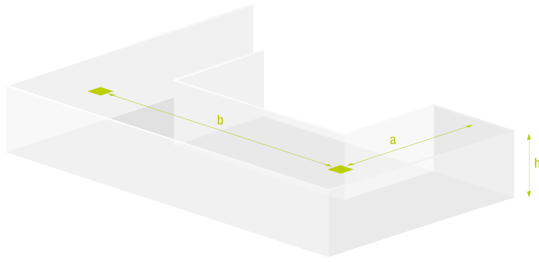

| h | a | b |
|-------|-------|--------|
| 2 m | 4,0 m | 16,4 m |
| 2.5 m | 4,7 m | 18,4 m |
| 3 m | 5,2 m | 19,7 m |
| 4 m | 5,8 m | 21,7 m |
| 5 m | 5,8 m | 20,1 m |

Afstandsgegevens berekend zonder reflecties en met een onderhoudsfactor van 0.9.

Conform aan de bijgewerkte norm EN-1838:2024.

Minimale verlichtingssterkte van 1 lux over een evacuatie pad van 1 m breed.

De berekening van de tussenafstanden wordt uitgevoerd rekening houdend met de hoogte van het lichtemissiepunt en zonder rekening te houden met de afmetingen van het armatuur.

Fotometrische richtlijn

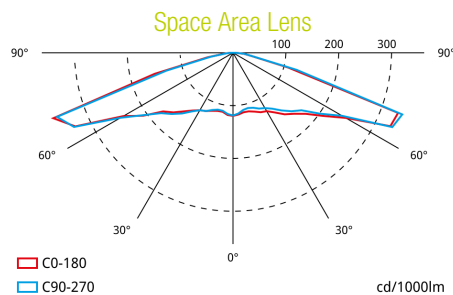
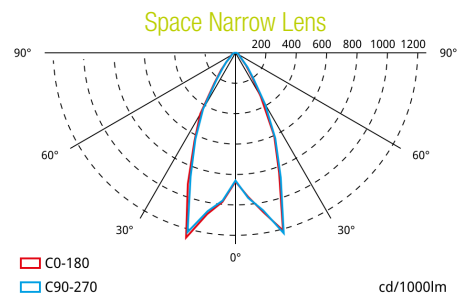
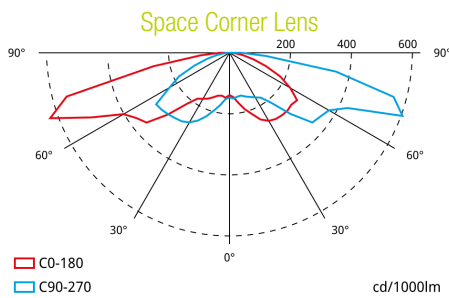
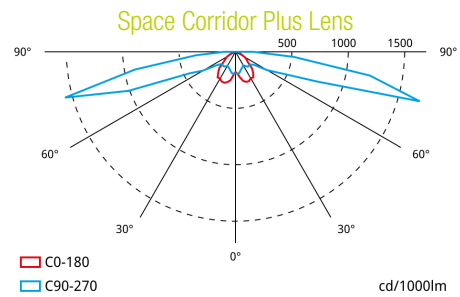
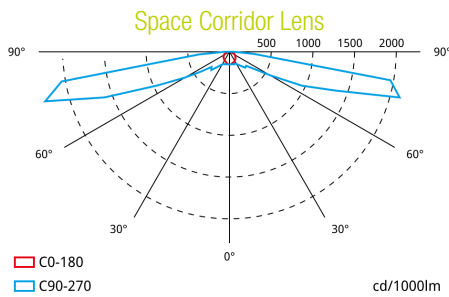

— Accessoires —



ACE0065
ACC. IP65 SPACE
WIT



CSZ003
SMARTZ CENTRAAL+ USV
CSZ002+SAI002



ZWEBDALI2
CENTRAL DALI2