

# MAXILUM EVO

IP65

IK07



**GARANTIE**  
**5 ANS**

## — Installation —

Mur	Surface	✓
	Encastré	✗
Plafond	Surface	✓
	Encastré	✗

## — Dimensions (mm) —

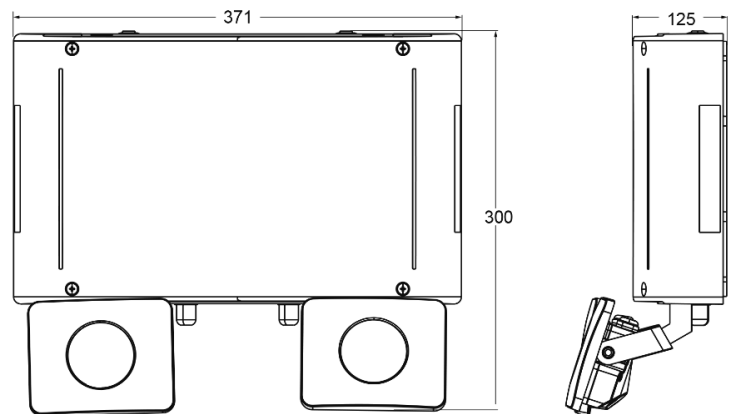

## — Spécification —

 Corps: Polycarbonate

 IP65

 IK07

 Flux assigné: 1500 ~ 3300 lm

 Autonomie: 1 h, 3 h  
Batterie: LiFePO<sub>4</sub>

 Temps de charge: 12 h, 24 h

 Fournir: 230V~ 50Hz 3.0 Wmax, 230V 50Hz

 LED Température de couleur: 4000 K

 Température de fonctionnement: 0/40 °C, -20/25 °C

 Auto-test

 DALI2

## — Conformité technique —

EN-303-446-1 EN-60598-1 EN-60598-2-22  
EN-62034 EN-62386

## — Certifications —



## — Gamme —



	Sécurité	Type*	Durée	Batterie	Référence
Auto-test	1500 lm	NP	1 h	12.8V-3.0Ah LiFePO <sub>4</sub>	PMV1500LX
	3300 lm	NP	1 h	2x 12.8V-3.0Ah LiFePO <sub>4</sub>	PMV3000LX
	1500 lm	NP	3 h	2x 12.8V-3.0Ah LiFePO <sub>4</sub>	PMV1500LX3
DALI 2	1500 lm	NP	1 h	12.8V-3.0Ah LiFePO <sub>4</sub>	PMV1500LA
	3300 lm	NP	1 h	2x 12.8V-3.0Ah LiFePO <sub>4</sub>	PMV3000LA
	1500 lm	NP	3 h	2x 12.8V-3.0Ah LiFePO <sub>4</sub>	PMV1500LA3
Wireless SmartZ®	1500 lm	NP	1 h	12.8V-3.0Ah LiFePO <sub>4</sub>	PMV1500LW
	3300 lm	NP	1 h	2x 12.8V-3.0Ah LiFePO <sub>4</sub>	PMV3000LW
	1500 lm	NP	3 h	2x 12.8V-3.0Ah LiFePO <sub>4</sub>	PMV1500LW3

## MAXILUM EVO FROID\*\*



	Sécurité	Type*	Durée	Batterie	Référence
Auto-test	1500 lm	NP	1 h	2x 12.8V-3.0Ah LiFePO <sub>4</sub>	PMV1500LX3F
	1500 lm	NP	1 h	12.8V-3.0Ah LiFePO <sub>4</sub>	PMV1500LXF
	3300 lm	NP	1 h	2x 12.8V-3.0Ah LiFePO <sub>4</sub>	PMV3000LXF
DALI 2	3300 lm	NP	1 h	2x 12.8V-3.0Ah LiFePO <sub>4</sub>	PMV3000LAF
	1500 lm	NP	3 h	12.8V-3.0Ah LiFePO <sub>4</sub>	PMV1500LA3F
	1500 lm	NP	1 h	12.8V-3.0Ah LiFePO <sub>4</sub>	PMV1500LWF
Wireless SmartZ®	3300 lm	NP	1 h	2x 12.8V-3.0Ah LiFePO <sub>4</sub>	PMV3000LWF
	1500 lm	NP	3 h	2x 12.8V-3.0Ah LiFePO <sub>4</sub>	PMV1500LW3F

\*NP: Non permanent. Le luminaire fonctionne sur l'alimentation de secours uniquement en cas d'interruption de l'alimentation secteur normale.

\*\* Références spéciales pour chambres froides.

## — Couleurs disponibles —



Pour la version noire, ajoutez "N" à la fin du numéro de pièce.

## — Tableau des interdistances —

Calculé pour référence PMV3000LX (3300 lm)

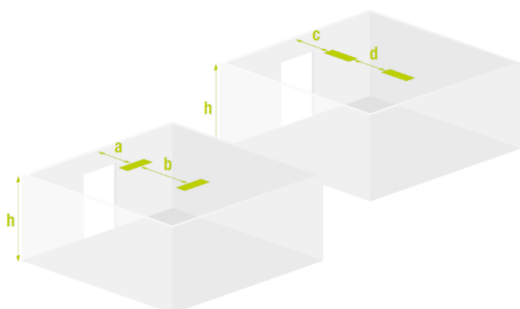

h	a	b	c	d
6 m	11,8 m	27,5 m	10,0 m	24,5 m
8 m	13,6 m	32,5 m	12,4 m	29,2 m
11 m	15,2 m	38,1 m	15,3 m	35,5 m
13 m	15,9 m	40,6 m	16,0 m	39,1 m
15 m	16,3 m	42,6 m	16,4 m	42,1 m

Données d'espacement calculées sans réflexions et avec un facteur de maintenance de 0.9.  
Conforme à la mise à jour de la norme EN-1838:2024.

Éclairage minimum de 1 lux sur une voie d'évacuation de 1 m de large.

Le calcul des espacements est effectué en considérant la hauteur du point d'émission de la lumière, sans tenir compte des dimensions du luminaire.

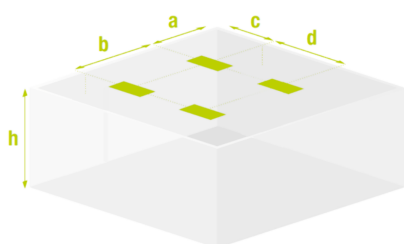

h	a	b	c	d
6 m	10,8 m	22,0 m	13,8 m	26,5 m
8 m	13,5 m	27,5 m	16,2 m	31,0 m
11 m	17,1 m	36,0 m	18,9 m	36,5 m
13 m	19,2 m	38,0 m	20,1 m	43,0 m
15 m	21,3 m	42,0 m	21,3 m	46,0 m

Données d'espacement calculées sans réflexions et avec un facteur de maintenance de 0.9.  
Conforme à la mise à jour de la norme EN-1838:2024.

Éclairage minimum de 0.5 (calcul anti-panique).

Le calcul des espacements est effectué en considérant la hauteur du point d'émission de la lumière, sans tenir compte des dimensions du luminaire.

## — Guide photométrique —

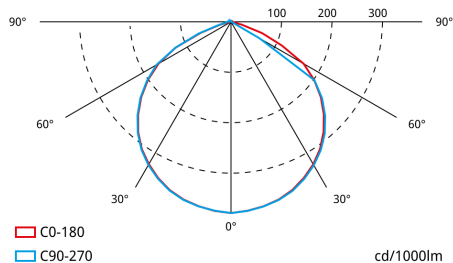

## — Accessoires —



AGM160  
ACC. GRILLE PROTEC. FLAT  
POUR BLOC PHARE



CSZ003  
SMARTZ CONTROL UNIT+ UAS  
CSZ002+SAI002

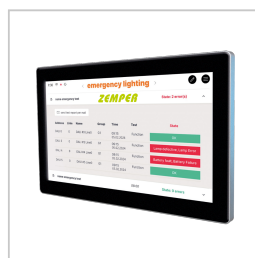

ZWEBDALI2  
CENTRAL DALI2