

# EXITALYA MAXI ENCASTRÉ

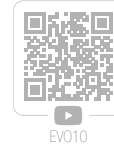

EXITALYA MAXI ENCASTRÉ



EVO10

IP42

IK04

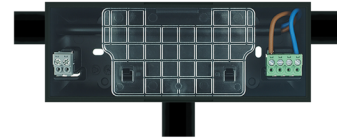

**GARANTIE**  
**5 ANS**

**EVO10**  
**GARANTIE**  
**10 ANS**

## — Installation —

Mur	Surface	✗
	Encastré	✗
Plafond	Surface	✗
	Encastré	✓

## — Dimensions (mm) —

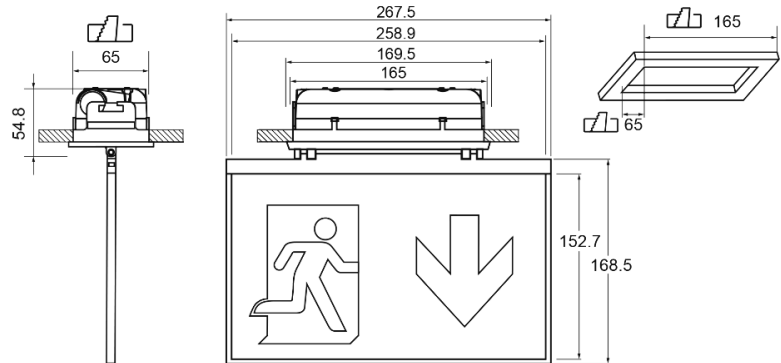



## — Spécification —

 Corps: Polycarbonate, Polycarbonate Recyclé

 IP IP42

 IK IK04

 Autonomie: 1 h, 3 h, 8 h  
Batterie: LiFePO<sub>4</sub>

 Temps de charge: 12 h



 Fournir: 230V 50Hz

 LED Température de couleur: 4000 K, 6500 K

 Température de fonctionnement: 0/40 °C

 Auto-test

 DALI2

  25 m

## — Conformité technique —

EN-303-446-1 EN-60598-1 EN-60598-2-22  
EN-62034 EN-62386

## — Certifications —



## — Gamme —

	Type*	Durée	Batterie	Référence
Auto-test	P/NP	1 h	3.2V-1.0Ah LiFePO <sub>4</sub>	LYR5070LXS
	P/NP	3 h	3.2V-1.5Ah LiFePO <sub>4</sub>	LYR5070LXS3
	P	1 h	3.2V-1.0Ah LiFePO <sub>4</sub>	LYR5070LXP
	P	3 h	3.2V-1.5Ah LiFePO <sub>4</sub>	LYR5070LXP3
DALI	P/NP	1 h	3.2V-1.0Ah LiFePO <sub>4</sub>	LYR5070LAS
	P/NP	3 h	3.2V-1.5Ah LiFePO <sub>4</sub>	LYR5070LAS3
	P	1 h	3.2V-1.0Ah LiFePO <sub>4</sub>	LYR5070LAP
	P	3 h	3.2V-1.5Ah LiFePO <sub>4</sub>	LYR5070LAP3
	P	3 h	3.2V-3.0Ah LiFePO <sub>4</sub>	LYRX5070LAP3
Wireless SmartZ®	P/NP	1 h	3.2V-1.0Ah LiFePO <sub>4</sub>	LYR5070LWS
	P/NP	3 h	3.2V-1.5Ah LiFePO <sub>4</sub>	LYR5070LWS3
	P/NP	8 h	3.2V-3.0Ah LiFePO <sub>4</sub>	LYR5070LWS8
	P	1 h	3.2V-1.0Ah LiFePO <sub>4</sub>	LYR5070LWP
	P	3 h	3.2V-1.5Ah LiFePO <sub>4</sub>	LYR5070LWP3
	P	8 h	3.2V-3.0Ah LiFePO <sub>4</sub>	LYR5070LWP8

**EVOLIO GARANTIE 10 ANS**

	Type*	Durée	Batterie	Référence
DALI	P	1 h	3.2V-1.5Ah LiFePO <sub>4</sub>	LYRX5070LAP
	P	1 h	3.2V-1.5Ah LiFePO <sub>4</sub>	LYRX5070LWP
	P	3 h	3.2V-3.0Ah LiFePO <sub>4</sub>	LYRX5070LWP3

Wireless SmartZ®



8

\*P: Permanent

\*P/NP: Permanent/Non permanent. Avec une troisième borne qui permet d'activer/de désactiver le mode Permanent lorsqu'il est connecté à l'alimentation secteur.

## — Couleurs disponibles —



Pour la version noire, ajoutez "N" à la fin du numéro de pièce.

## — Accessoires —



CSZ003  
SMARTZ CONTROL UNIT+ UAS  
CSZ002+SAI002

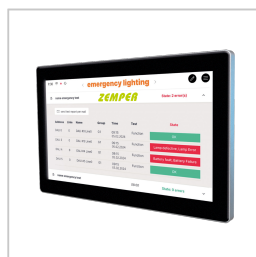

ZWEBDALI2  
CENTRAL DALI2