

SPAZIO PLUS TRACK



IP20

IK04



WARRANTY
5
YEAR

— Installation —

Track

— Dimensions (mm) —

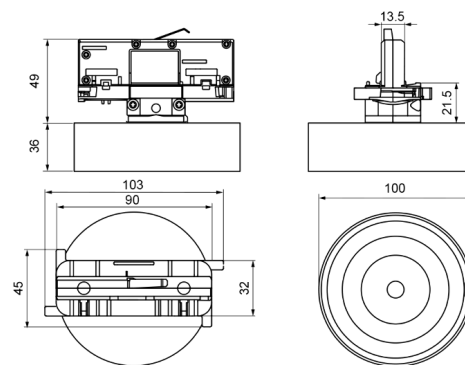

— Specification —

 Body: Polycarbonate

 IP20

 IK04

 Emergency: 165 ~ 250 lm
Mains: 100 ~ 150 lm

 Autonomy: 1 h, 3 h
Battery: LiFePO₄

 Charging time: 12 h

 Supply: 230V 50Hz

 LED Colour temperature: 4000 K

 Working temperature: 0/40 °C

 AutoTest

 DALI2

— Technical compliance —

EN-303-446-1 EN-60598-1 EN-60598-2-22
EN-62034

— Certifications —

— Range —

	Emergency	Mains	Type*	Lens	Dur.	Battery	Part number
AutoTest	250 lm	150 lm	M/NM	Anti-panic and Escape Route	1 h	3.2V-1.5Ah LiFePO ₄	LSP6255LXP
	165 lm	100 lm	M/NM	Anti-panic and Escape Route	3 h	3.2V-1.8Ah LiFePO ₄	LSP6175LXP3
	250 lm	150 lm	M/NM	Anti-panic and Escape Route	1 h	3.2V-1.5Ah LiFePO ₄	LSP6255LAP
	165 lm	100 lm	M/NM	Anti-panic and Escape Route	3 h	3.2V-1.8Ah LiFePO ₄	LSP6175LAP3
Wireless SmartZ®	250 lm	150 lm	M/NM	Anti-panic and Escape Route	1 h	3.2V-1.5Ah LiFePO ₄	LSP6255LWP
	165 lm	100 lm	M/NM	Anti-panic and Escape Route	3 h	3.2V-1.8Ah LiFePO ₄	LSP6175LWP3

 12 / 36 / 37

*M/NM: Maintained/Non Maintained. With a third terminal which allows to switch off/on the Maintained mode when connected to mains supply.

— Available colours —



For black version, add "N" at the end of the part number.

— Spacing table —

Calculated for reference LSP6255LWP (250 lm)

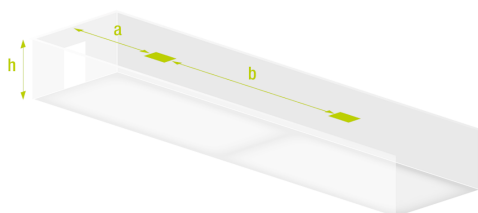

Escape route lens

h	a	b
2 m	8,1 m	19,2 m
2.5 m	9,4 m	22,2 m
3 m	10,3 m	25,0 m
4 m	5,9 m	26,5 m
5 m	4,1 m	25,5 m

Spacing data calculated with no reflections and a maintenance factor of 0.9.

Compliant with the updated standard EN-1838:2024.

Minimum illuminance of 1 lux over a 1 m wide evacuation path.

The calculation of spacing distances is carried out considering the height of the light emission point, without taking into account the dimensions of the luminaire.

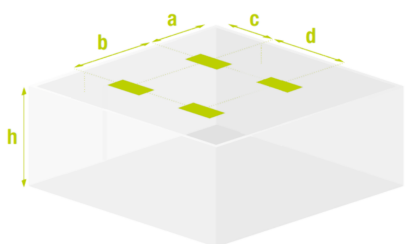

Anti-panic lens

h	a	b	c	d
2 m	3,6 m	7,0 m	3,6 m	7,0 m
2.5 m	4,2 m	8,0 m	4,2 m	8,5 m
3 m	4,8 m	9,0 m	4,8 m	9,0 m
4 m	5,7 m	11,0 m	5,7 m	11,0 m
5 m	6,3 m	12,5 m	6,3 m	13,0 m

Spacing data calculated with no reflections and a maintenance factor of 0.9.

Compliant with the updated standard EN-1838:2024.

Minimum illuminance of 0.5 (anti-panic calculation).

The calculation of spacing distances is carried out considering the height of the light emission point, without taking into account the dimensions of the luminaire.

— Photometric guide —

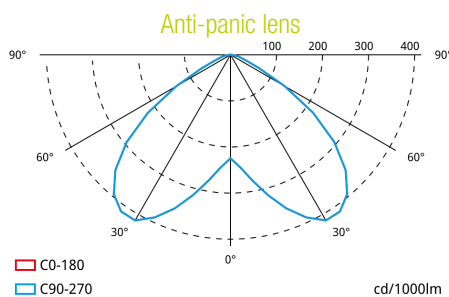
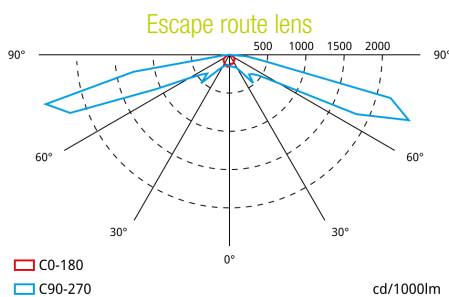

— Accessories —



CSZ003
SMARTZ CONTROL UNIT+ UPS
CSZ002+SAI002



ZWEBDALI2
CENTRAL DALI2