

CORKIA SPACE

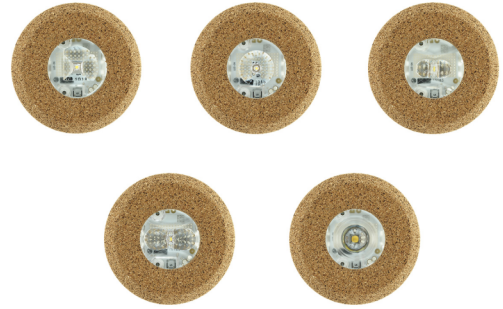

IP44

IK04



WARRANTY
5
YEAR

— Installation —

Wall	Surface	✗
	Recessed	✗
Ceiling	Surface	✗
	Recessed	✓

— Dimensions (mm) —

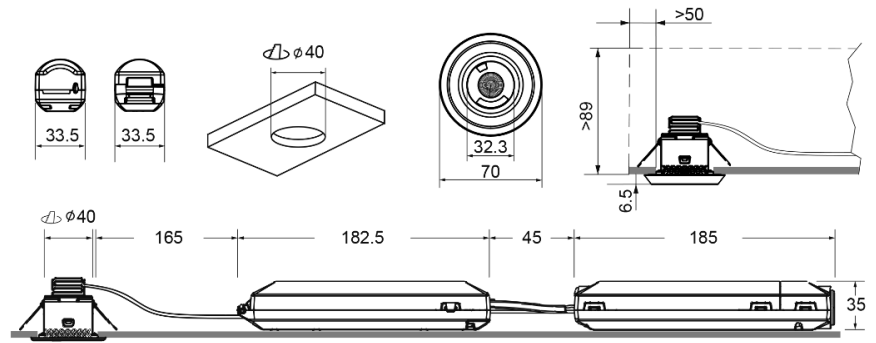

— Specification —

Body: Cork

IP44

IK04

Emergency: 370 ~ 420 lm

Autonomy: 1 h, 3 h
Battery: LiFePO₄

Charging time: 12 h

Supply: 230V 50Hz

LED Colour temperature: 4000 K

Working temperature: 0/40 °C

AutoTest

DALI2

— Technical compliance —

EN-303-446-1 EN-60598-1 EN-60598-2-22
EN-62034 EN-62386

— Certifications —

— Range —

	Emergency	Type*	Lens	Dur.	Battery	Part number
AutoTest	370 lm	NM	Escape Route +	1 h	6.4V-1.5Ah LiFePO ₄	LCR3402LX
	380 lm	NM	Corner	1 h	6.4V-1.5Ah LiFePO ₄	LCR3403LX
	400 lm	NM	Narrow	1 h	6.4V-1.5Ah LiFePO ₄	LCR3404LX
	420 lm	NM	Antipanic	1 h	6.4V-1.5Ah LiFePO ₄	LCR3400LX
	370 lm	NM	Escape Route +	3 h	6.4V-4.0Ah LiFePO ₄	LCR3402LX3
	380 lm	NM	Corner	3 h	6.4V-4.0Ah LiFePO ₄	LCR3403LX3
	400 lm	NM	Narrow	3 h	6.4V-4.0Ah LiFePO ₄	LCR3404LX3
	420 lm	NM	Antipanic	3 h	6.4V-4.0Ah LiFePO ₄	LCR3400LX3
	370 lm	NM	Escape Route +	1 h	6.4V-1.5Ah LiFePO ₄	LCR3402LA
	380 lm	NM	Corner	1 h	6.4V-1.5Ah LiFePO ₄	LCR3403LA
	400 lm	NM	Narrow	1 h	6.4V-1.5Ah LiFePO ₄	LCR3404LA
	420 lm	NM	Antipanic	1 h	6.4V-1.5Ah LiFePO ₄	LCR3400LA
	370 lm	NM	Escape Route +	3 h	6.4V-4.0Ah LiFePO ₄	LCR3402LA3
	380 lm	NM	Corner	3 h	6.4V-4.0Ah LiFePO ₄	LCR3403LA3
	400 lm	NM	Narrow	3 h	6.4V-4.0Ah LiFePO ₄	LCR3404LA3
	420 lm	NM	Antipanic	3 h	6.4V-4.0Ah LiFePO ₄	LCR3400LA3
Wireless SmartZ®	370 lm	NM	Escape Route +	1 h	6.4V-1.5Ah LiFePO ₄	LCR3402LW
	380 lm	NM	Corner	1 h	6.4V-1.5Ah LiFePO ₄	LCR3403LW
	400 lm	NM	Narrow	1 h	6.4V-1.5Ah LiFePO ₄	LCR3404LW
	420 lm	NM	Antipanic	1 h	6.4V-1.5Ah LiFePO ₄	LCR3400LW
	370 lm	NM	Escape Route +	3 h	6.4V-4.0Ah LiFePO ₄	LCR3402LW3
	380 lm	NM	Corner	3 h	6.4V-4.0Ah LiFePO ₄	LCR3403LW3
	400 lm	NM	Narrow	3 h	6.4V-4.0Ah LiFePO ₄	LCR3404LW3
	420 lm	NM	Antipanic	3 h	6.4V-4.0Ah LiFePO ₄	LCR3400LW3

*NM: Non-maintained. The luminaire operates from emergency supply only upon failure of the normal mains supply.

— Spacing table —

Calculated for reference LCR3404LW3 (400 lm)

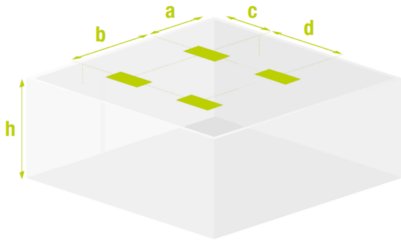

h	a	b	c	d
6 m	5,1 m	10,5 m	4,8 m	10,5 m
8 m	5,7 m	12,0 m	5,7 m	12,5 m
11 m	6,9 m	14,5 m	6,6 m	14,5 m
13 m	7,5 m	15,5 m	7,2 m	16,0 m
15 m	8,1 m	17,0 m	7,8 m	17,0 m

Spacing data calculated with no reflections and a maintenance factor of 0.9.

Compliant with the updated standard EN-1838:2024.

Minimum illuminance of 0.5 (anti-panic calculation).

The calculation of spacing distances is carried out considering the height of the light emission point, without taking into account the dimensions of the luminaire.

— Photometric guide —

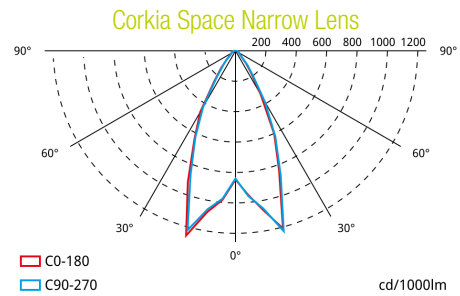
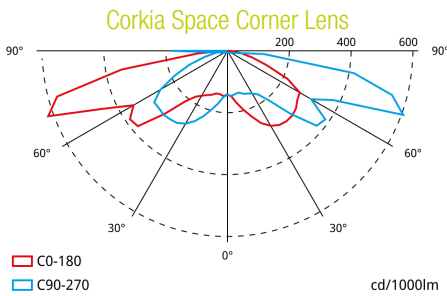
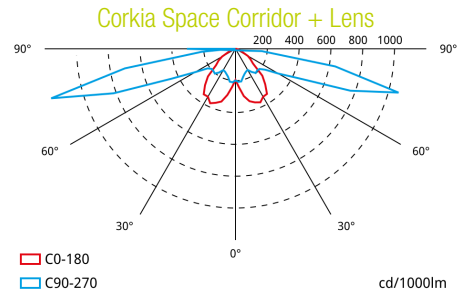
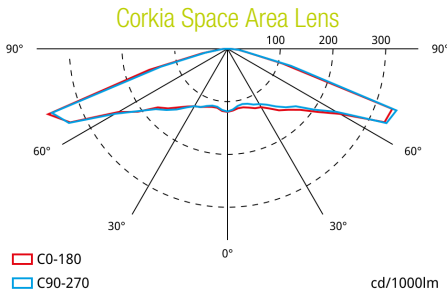

— Accessories —



CSZ003
SMARTZ CONTROL UNIT+ UPS
CSZ002+SAI002

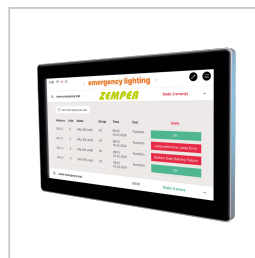

ZWEBDALI2
CENTRAL DALI2